



Axial inline fans

Axis-F

Air capacity – up to 11900 m³/h

Use

- Supply and exhaust ventilation systems installed in various premises.
- Ideal solution for boosting large air volumes at low aerodynamic resistance in the ventilation system.

Design

- Compact steel casing and impeller with a special polymer coating.
- Casing is equipped with connecting flanges for easy mounting into air duct.
- The fan is equipped with a terminal block for connection to power mains.

Motor

- Two- or four-pole asynchronous motor with external rotor and axial impeller.
- Single-phase (**E**) or three-phase (**D**) motor modifications.
- Equipped with ball bearings for longer service life.
- Integrated thermal protection with automatic restart.

Speed control

- Smooth speed control with an external thyristor controller or step speed control with an external auto transformer (both available upon separate order).

Mounting

- The fan is installed in air ducts by connecting flanges on the fan casing.
- Mounting in any position with respect to air flow direction in the system.
- Power is supplied through an external terminal box.

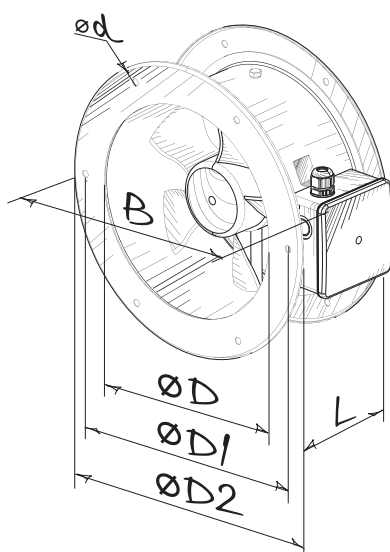

Overall dimensions



Type	Dimensions [mm]						Weight [kg]
	ØD	ØD1	ØD2	Ød	B	L	
Axis-F 200 2E	205	235	255	7	290	120	1.95
Axis-F 250 2E	260	286	306	7	340	150	3.84
Axis-F 250 4E	260	286	306	7	340	150	3.96
Axis-F 300 2E	310	356	382	7	410	160	5.31
Axis-F 300 4E	310	356	382	7	420	160	5.59
Axis-F 350 4E	362	395	421	9.5	480	160	6.37
Axis-F 400 4E	412	438	465	9.5	550	170	8.39
Axis-F 450 4E	462	487	515	9.5	630	200	10.65
Axis-F 500 4E	515	541	570	9.5	635	220	12.65
Axis-F 550 4E	565	605	636	11.5	685	230	17.3
Axis-F 630 4E	645	674	715	11.5	780	250	20.13
Axis-F 250 2D	260	286	306	7	340	150	3.84
Axis-F 250 4D	260	286	306	7	340	150	3.84
Axis-F 300 2D	310	356	382	7	420	160	5.31
Axis-F 300 4D	310	356	382	7	420	160	5.31
Axis-F 350 4D	362	395	421	9.5	480	160	6.37
Axis-F 400 4D	412	438	465	9.5	550	170	8.39
Axis-F 450 4D	462	487	515	9.5	630	200	10.65

ErP data	
Overall efficiency	η, (%)
Measurement category	MC
Efficiency category	EC
Efficiency grade	N
Variable speed drive	VSD
Power	[kW]
Current	[A]
Air flow	[m ³ /h]
Static pressure	[Pa]
Speed	[n/min ⁻¹]
Specific ratio	SR

Specifications

Parameters	Axis-F 200 2E*	Axis-F 250 2E*	Axis-F 250 4E*	Axis-F 300 2E 	Axis-F 300 4E*	Axis-F 350 4E 	Axis-F 400 4E 
Voltage [V / 50 Hz]	230	230	230	230	230	230	230
Power [W]	55	80	50	145	75	140	180
Current [A]	0.26	0.4	0.22	0.66	0.35	0.65	0.82
Maximum air capacity [m³/h]	860	1050	800	2230	1340	2500	3580
RPM [min ⁻¹]	2300	2400	1380	2300	1350	1380	1380
Sound pressure level at 3 m distance [dBA]	50	60	55	60	58	62	63
Max. operating temperature [°C]	-30 +60	-30 +60	-30 +60	-30 +60	-30 +60	-30 +60	-30 +60
SEC class	C	B	-	-	B	-	-
Ingress protection rating	IPX4	IPX4	IPX4	IPX4	IPX4	IPX4	IPX4

* Compliant to the ErP-regulation (EC) 327/2011, the power consumption at optimum efficiency is < 125W.

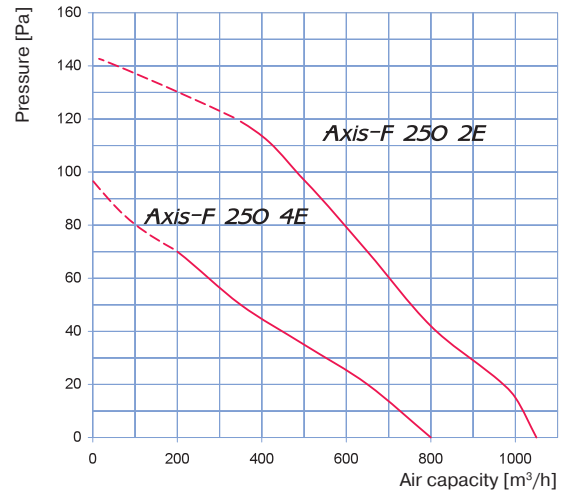
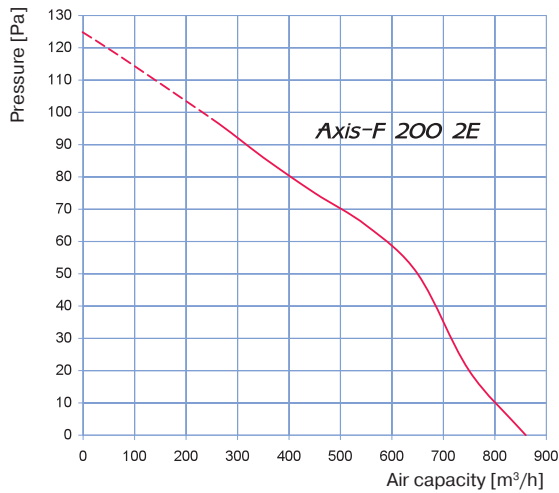

Sound-power level	Octave-frequency band [Hz]								
	Gen	63	125	250	500	1000	2000	4000	8000
L _{WA} to environment, [dBA]	65	56	58	58	57	59	55	51	45

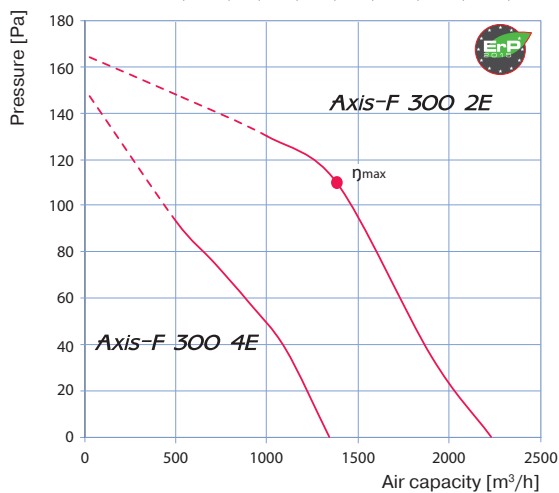

Sound-power level	Octave-frequency band [Hz]								
	Gen	63	125	250	500	1000	2000	4000	8000
Axis-F 300 2E	78	72	72	70	72	70	69	63	63
Axis-F 300 4E	67	58	57	59	57	58	53	52	49

Axis-F 300 2E										
η _v (%)	MC	EC	N	VSD	[kW]	[A]	[m³/h]	[Pa]	[RPM]	SR
30.5	A	Static	42.2	No	0.141	0.64	1380	110	2350	1

Sound-power level	Octave-frequency band [Hz]								
	Gen	63	125	250	500	1000	2000	4000	8000
Axis-F 250 2E	76	68	66	68	70	68	68	63	58
Axis-F 250 4E	60	52	50	52	53	52	52	44	43

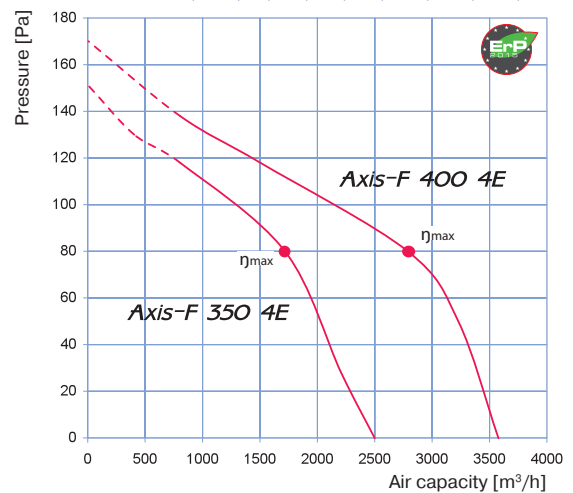

Sound-power level	Octave-frequency band [Hz]								
	Gen	63	125	250	500	1000	2000	4000	8000
Axis-F 350 4E	70	61	62	64	63	63	58	56	52
Axis-F 400 4E	75	66	68	66	69	67	65	61	56

Axis-F 350 4E										
η _v (%)	MC	EC	N	VSD	[kW]	[A]	[m³/h]	[Pa]	[RPM]	SR
29.9	A	Static	41.8	No	0.130	0.6	1717	80	1375	1

Axis-F 400 4E										
η _v (%)	MC	EC	N	VSD	[kW]	[A]	[m³/h]	[Pa]	[RPM]	SR
33.8	A	Static	44.8	No	0.187	0.86	2787	80	1355	1

Specifications

Parameters	Axis-F 450 4E 	Axis-F 500 4E 	Axis-F 550 4E 	Axis-F 630 4E 	Axis-F 250 2D*	Axis-F 250 4D*
Voltage [V / 50 Hz]	230	230	230	230	400	400
Power [W]	250	420	550	750	80	60
Current [A]	1.2	1.95	2.55	3.5	0.22	0.17
Maximum air capacity [m³/h]	4680	7060	8800	11900	1060	850
RPM [min ⁻¹]	1350	1300	1300	1360	2600	1400
Sound pressure level at 3 m distance [dBA]	64	69	70	75	60	55
Max. operating temperature [°C]	-30 +60	-30 +60	-30 +60	-30 +60	-30 +60	-30 +60
SEC class	-	-	-	-	B	-
Ingress protection rating	IPX4	IPX4	IPX4	IPX4	IPX4	IPX4

* Compliant to the ErP-regulation (EC) 327/2011, the power consumption at optimum efficiency is < 125W.

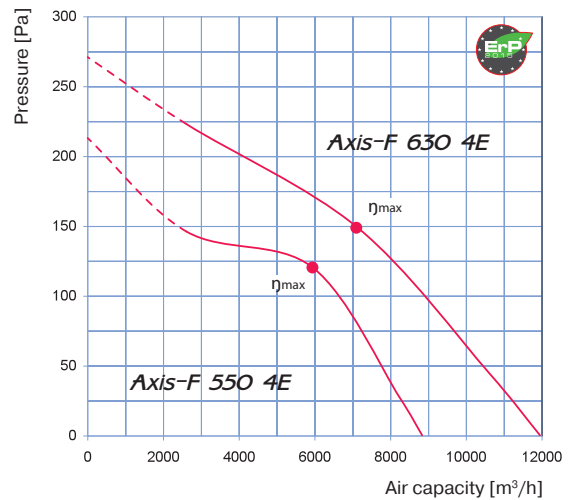
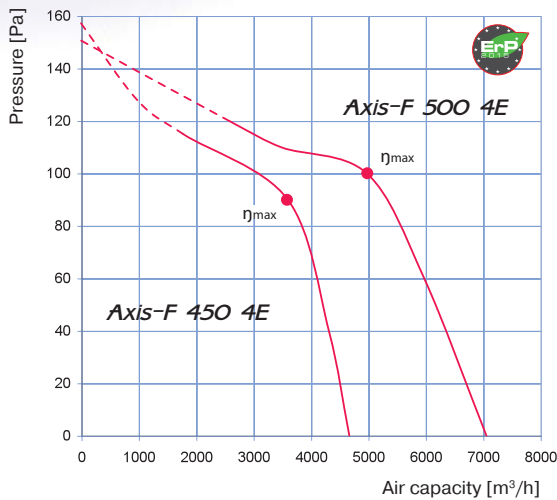

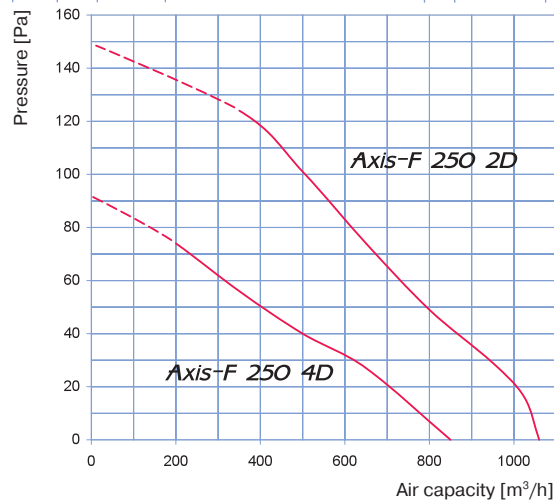

Sound-power level	Octave-frequency band [Hz]									
	Gen	63	125	250	500	1000	2000	4000	8000	
Axis-F 450 4E										
L _{WA} to environment, [dBA]	77	69	70	73	73	71	67	67	61	
Axis-F 500 4E										
L _{WA} to environment, [dBA]	80	71	73	72	74	73	70	67	63	
Axis-F 450 4E										
η, (%)	MC	EC	N	VSD	[kW]	[A]	[m³/h]	[Pa]	[RPM]	SR
32.0	A	Static	41.8	No	0.288	1.31	3610	90	1270	1
Axis-F 500 4E										
η, (%)	MC	EC	N	VSD	[kW]	[A]	[m³/h]	[Pa]	[RPM]	SR
32.1	A	Static	40.7	No	0.440	2.01	4987	100	1285	1

Sound-power level	Octave-frequency band [Hz]									
	Gen	63	125	250	500	1000	2000	4000	8000	
Axis-F 550 4E										
L _{WA} to environment, [dBA]	83	73	75	73	75	74	72	66	63	
Axis-F 630 4E										
L _{WA} to environment, [dBA]	77	71	73	72	73	71	70	63	59	
Axis-F 550 4E										
η, (%)	MC	EC	N	VSD	[kW]	[A]	[m³/h]	[Pa]	[RPM]	SR
34.7	A	Static	42.6	No	0.581	2.64	5919	120	1240	1
Axis-F 630 4E										
η, (%)	MC	EC	N	VSD	[kW]	[A]	[m³/h]	[Pa]	[RPM]	SR
37.5	A	Static	44.4	No	0.800	3.76	7095	149	1290	1



Sound-power level	Octave-frequency band [Hz]								
	Gen	63	125	250	500	1000	2000	4000	8000
Axis-F 250 2D									
L _{WA} to environment, [dBA]	77	67	68	70	69	68	66	60	57
Axis-F 250 4D									
L _{WA} to environment, [dBA]	60	49	50	53	54	53	52	45	42

Specifications

Parameters	Axis-F 300 2D 	Axis-F 300 4D*	Axis-F 350 4D 	Axis-F 400 4D 	Axis-F 450 4D 
Voltage [V / 50 Hz]	400	400	400	400	400
Power [W]	145	75	140	180	250
Current [A]	0.25	0.22	0.38	0.47	0.6
Maximum air capacity [m ³ /h]	2310	1310	2520	3740	5280
RPM [min ⁻¹]	2350	1380	1380	1380	1360
Sound pressure level at 3 m distance [dBA]	60	58	62	64	65
Max. operating temperature [°C]	-30 +60	-30 +60	-30 +60	-30 +60	-30 +60
SEC class	-	B	-	-	-
Ingress protection rating	IPX4	IPX4	IPX4	IPX4	IPX4

* Compliant to the ErP-regulation (EC) 327/2011, the power consumption at optimum efficiency is < 125W.

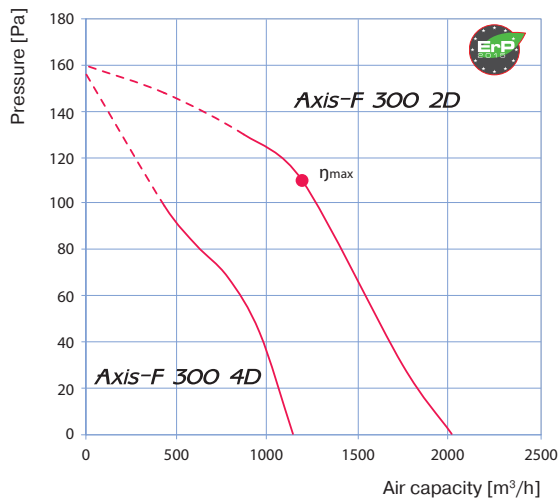

Sound-power level	Octave-frequency band [Hz]								
	Gen	63	125	250	500	1000	2000	4000	8000
Axis-F 300 2D									
L _{WA} to environment, [dBA]	80	72	71	71	74	70	69	65	63
Axis-F 300 4D									
L _{WA} to environment, [dBA]	63	58	55	58	56	58	57	52	48

η _v (%)	MC	EC	N	VSD	[kW]	[A]	[m ³ /h]	[Pa]	[RPM]	SR
30.3	A	Static	42	No	0.141	0.25	1367	110	2350	1

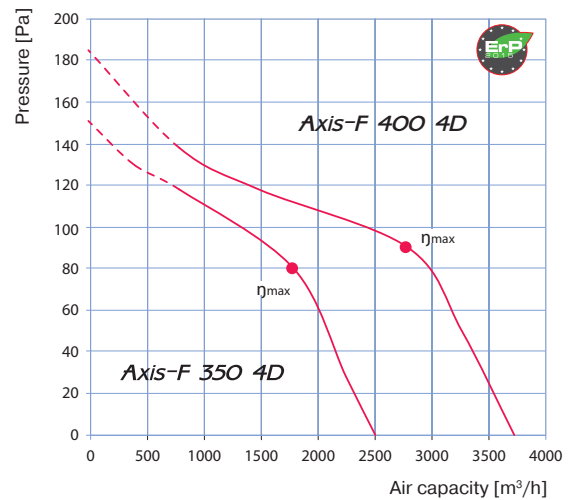

Sound-power level	Octave-frequency band [Hz]								
	Gen	63	125	250	500	1000	2000	4000	8000
Axis-F 350 4D									
L _{WA} to environment, [dBA]	72	62	61	64	64	61	61	56	54
Axis-F 400 4D									
L _{WA} to environment, [dBA]	75	65	66	69	66	67	64	60	55

η _v (%)	MC	EC	N	VSD	[kW]	[A]	[m ³ /h]	[Pa]	[RPM]	SR
31.7	A	Static	43.7	No	0.129	0.37	1802	80	1400	1

η _v (%)	MC	EC	N	VSD	[kW]	[A]	[m ³ /h]	[Pa]	[RPM]	SR
34.3	A	Static	44.9	No	0.209	0.47	2807	90	1365	1

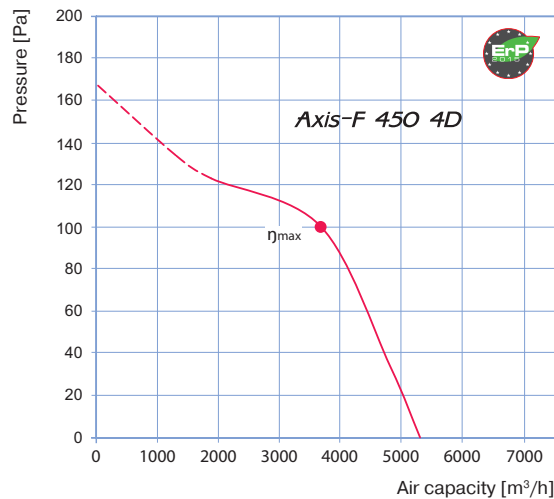

Sound-power level	Octave-frequency band [Hz]								
	Gen	63	125	250	500	1000	2000	4000	8000
L _{WA} to environment, [dBA]	76	65	68	69	69	70	64	60	57

η _v (%)	MC	EC	N	VSD	[kW]	[A]	[m ³ /h]	[Pa]	[RPM]	SR
35.1	A	Static	44.8	No	0.296	0.59	3659	100	1310	1